

Vanishing™ S E R I E S

LS Model

80F/X®-LS

RT Models

80F/X®-RT

620-RT

polkaudio®

the speaker
specialists®

ENGLISH

IMPORTANT SAFETY INSTRUCTIONS

READ BEFORE OPERATING EQUIPMENT

1. Read these instructions.
2. Keep these instructions.
3. Heed all warnings.
4. Follow all instructions.
5. Do not use this apparatus near water.
6. Clean only with dry cloth.
7. Do not block any ventilation openings. Install in accordance with the manufacturer's instructions.
8. Do not install near any heat sources such as radiators, heat registers, stoves, or other apparatus (including amplifiers) that produce heat.
9. Refer all servicing to qualified service personnel. Servicing is required when the apparatus has been damaged in any way, liquid has been spilled or objects have fallen into the apparatus, the apparatus has been exposed to rain or moisture, does not operate normally, or has been dropped.
10. **WARNING:** To reduce the risk of fire or electric shock, this apparatus should not be exposed to rain or moisture and objects filled with liquids, such as vases, should not be placed on this apparatus.



Product Disposal—Certain international, national and/or local laws and/or regulations may apply regarding the disposal of this product. For further detailed information, please contact the retailer where you purchased this product or the Polk Audio Importer/

Distributor in your country. A listing of Polk Audio Importer/Distributors can be found on the Polk Audio website www.polkaudio.com or by contacting Polk Audio at 5601 Metro Drive, Baltimore, Maryland 21215, USA—Phone: +1 410 358-3600.

WARNING: Listen Carefully

Polk Audio loudspeakers and subwoofers are capable of playing at extremely high volume levels, which could cause serious or permanent hearing damage. Polk Audio, Inc. accepts no liability for hearing loss, bodily injury or property damage resulting from the misuse of its products.

Keep these guidelines in mind and always use your own good judgment when controlling volume:

- You should limit prolonged exposure to volumes that exceed 85 decibels(dB).

For more about safe volume levels, go to the Occupational Health and Safety Administration (OSHA) guidelines at http://www.osha.gov/dts/osta/otm/noise/standards_more.html

TAKE INVENTORY

Inside each speaker container, you should find the following:

1. One in-ceiling loudspeaker or one set of loudspeakers for F/X® models only.
2. Speaker cutout mounting template
3. One Sheer-Grille (for each speaker)
4. One Owner's Manual
5. Registration Card

Important Note: If anything is missing or damaged, or if your speaker fails to operate, notify Polk Audio Customer Support Services immediately at 800-377-7655.

INSTALLATION RECOMMENDATION FOR OPTIMUM PERFORMANCE

Important Note: Vanishing Series Loudspeakers are not magnetically shielded and should not be placed closer than 1' (30cm) from a CRT (tube) television or video monitor.

Important Note: You should have a thorough understanding of and adhere to all local building and fire codes. Also, you should be familiar with the area behind the wall or ceiling into which you plan to install your speakers. Always use wire that meets appropriate building and fire codes. (**Note:** Wiring is best performed by an experienced professional.)

When installing your loudspeakers, be aware of the weight of your particular model and the sturdiness of the material into which you are installing the speaker. Be aware of any concealed studs, electrical wiring or plumbing in the wall or ceiling into which you are installing the speakers.

If you doubt that you possess the necessary skills or tools, consult your Polk Audio dealer or a professional installer.

WIRE RECOMMENDATIONS

(minimum recommended)

Runs	Gauge
Lengths up to 25'	18 or 16
Lengths greater than 25' but less than 50'	16 or 14
Lengths greater than 50' but less than 75'	14 or 12
Lengths greater than 75'	12

LOUDSPEAKER INSTALLATION

You will need:

- Pencil for marking the location of installation.
- Keyhole saw, utility knife or material-appropriate tool for cutting drywall or other wall material.
- Screwdriver, preferably powered, with Phillips Head bit.
- Power drill with appropriate bit (optional, for starting wall cut).

Trace around the template.

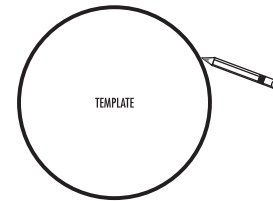

Cut the hole with the appropriate tool.

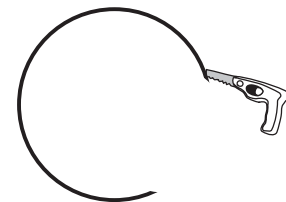

IMPORTANT INFORMATION BEFORE YOU INSTALL YOUR LOUDSPEAKERS

Wall Or Ceiling Surface Preparation

If you're installing your Vanishing Series speaker into a heavily textured wall or ceiling (e.g. stucco or popcorn finish), **you must prepare the wall surface immediately around the speaker cutout.** Sanding and smoothing the wall or ceiling surface will ensure the speaker and grille both seat properly and flat to the surface.

IMPORTANT INFORMATION SHOULD YOU CHOOSE TO PAINT YOUR GRILLES

Because of its ultra-thin profile, the Vanishing Series Sheer-Grille™ requires a specific painting procedure to ensure smooth, even coverage. The grille scrim and perforated grille come assembled and require no disassembly.

Paint Recommendation

We highly recommend you use a can of spray paint matched to the ceiling color you want the Sheer-Grilles to blend with.

Important Note: Never use a brush or roller to paint the grilles, as this will clog the perf holes.

To paint the Sheer-Grille

1. Elevate the Sheer-Grille off of a flat surface. This will ensure even coverage of the grille frame and make it easier to pick up. **Mounting Idea:** A single spray can cap will raise the grille high enough.
2. Hold the spray paint about 12" from the grille and at a 45° angle.

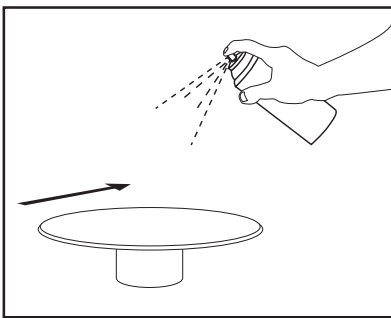

3. Apply one light, thin coat, moving evenly side to side over the grille, then work your way around the perimeter of the grille to ensure you cover the grille frame.
4. After each application of paint, wait approximately 1 minute, rotate the grille 90°, and apply the next thin coat.

Important Note: You must rotate the grille 90°. Use your hands to define the next 90° rotation and always rotate the grille in the same direction of travel.

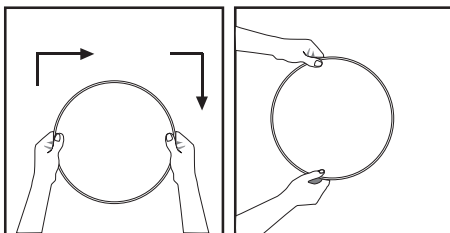

5. Three light, even applications should cover the grille and frame adequately. Remember to work your way around the grille frame to cover it evenly and completely.

SURROUND SPEAKER PLACEMENT

Polk Audio F/X® surround loudspeakers give you nearly endless placement options. But remember that where you place your surround speakers requires some careful thought, as installation requires that you cut a hole in your wall or ceiling.

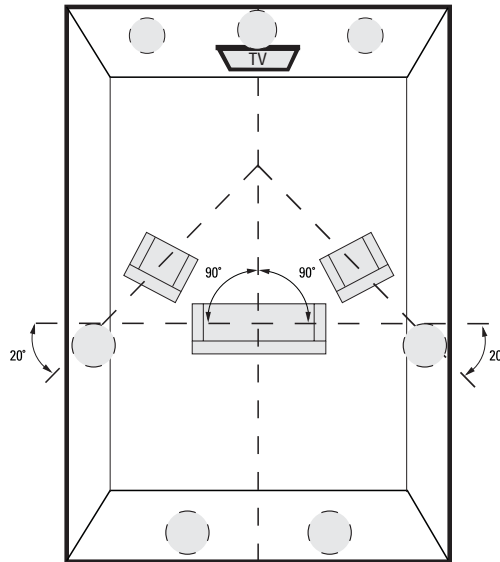
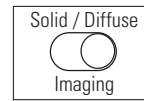

Diagram shows speaker locations for 5.1 and 7.1 systems, when two additional in-ceiling speakers are installed at back of the room.

Left/Right Orientation: F/X® surround loudspeakers have a left/right orientation, and each speaker is clearly marked on the serial number label on the back of the magnet for installation on either the right or left. Right and left are defined from your listening area as you face your system's center channel.

Please Note: For more on speaker placement go to: www.polkaudio.com/education/article.php?id=15 or www.polkaudio.com/downloads/hthandbook.pdf

ROOM ENVIRONMENT CONTROLS



Imaging (80F/x-LS only)
F/X Surround Loudspeakers offer switchable "Diffuse" and "Solid" imaging patterns to create the surround effect you desire.

A "Diffuse" image is defined as one which creates a "cloud" of sound; think of the effect as ambient sounds which fill the environment all around you, but are less localizable.

A "Solid" image is one which creates a more pin-point sound; sound is more localized. The location of sounds in the sound field is more identifiable.

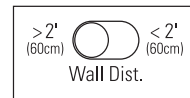

Wall Distance Switch (F/X models only)
In-ceiling loudspeakers excel when placed more than 2' (60cm) from side walls. If position limitations demand that in-ceiling loudspeakers be installed closer than 2' (60cm) from side walls, the proximity of the surface can result in a response "bump" between 50 and 200Hz. This can cause in-ceiling speakers to sound "boomy." The "Wall Distance" switch flattens response and eliminates "boominess" without sacrificing deep bass response, for more lifelike sound.

DIMENSIONS			
Model	80F/X-LS	80F/X-RT	620-RT
A. Overall Dimensions	11 1/8" (282.6mm)	11 1/8" (282.6mm)	9 5/8" (244.5mm)
B. Cutout Dimensions	9 3/8" (238.1mm)	9 3/8" (238.1mm)	8 3/16" (208mm)
C. Product Depth	5 1/8" (130.2mm)	4 3/4" (120.7mm)	4 1/4" (108mm)
D. Mounting Depth (using 1/2" drywall)	4 5/8" (117.5mm)	4 1/4" (108mm)	3 3/4" (95.3mm)

SPECIFICATIONS

For complete Vanishing Series specifications, visit www.polkaudio.com

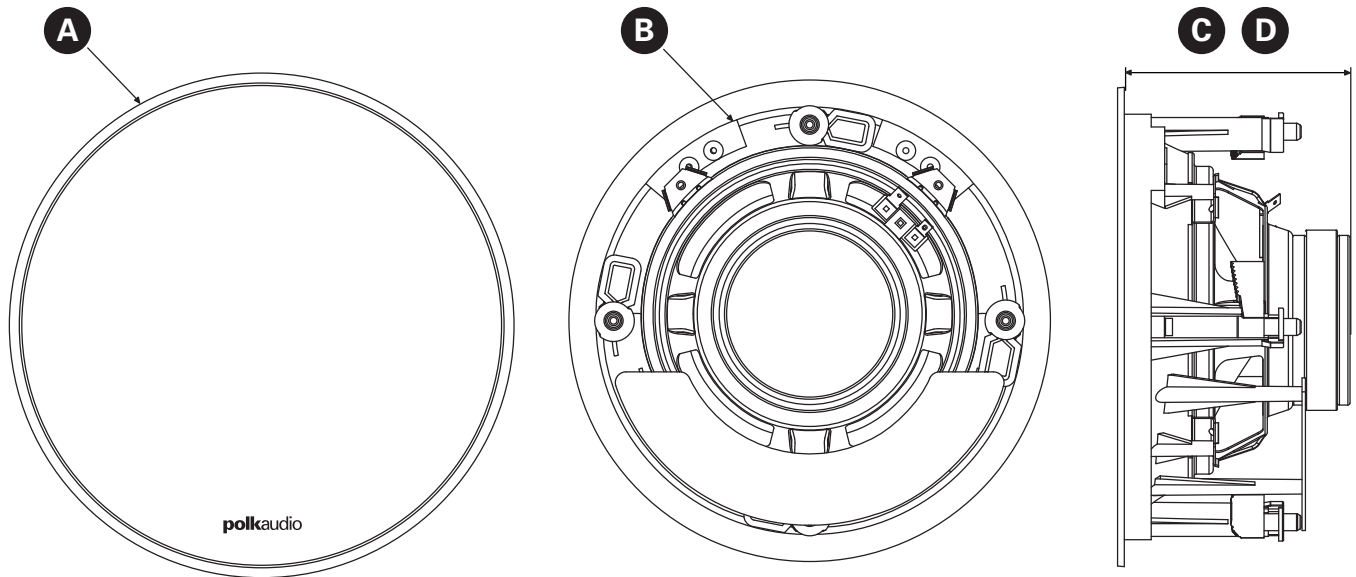

Limited Lifetime Warranty for Polk Audio-Branded In-Wall and In-Ceiling Speakers

Important Note: This lifetime warranty applies only to in-wall and in-ceiling loudspeakers, and passive CSW subwoofers sold after September 9, 2009.

Polk Audio, Inc., ("Polk") warrants to the original retail purchaser that Polk Audio branded in-wall and in-ceiling speakers, including passive CSW series subwoofers (collectively "product"), will be free from defects in materials and workmanship for the life of the product, under normal use and conditions. Should this product prove to be defective in material or workmanship, Polk will, at its option, (a) repair the product, or (b) replace the product. If the product model is no longer available and cannot be repaired effectively, or replaced with an identical model, Polk may, at its sole and absolute option, replace the unit with a current model of equal or greater value.

To obtain warranty service, you may refer to the instructions in your owner's manual or visit the Polk Audio website at www.polkaudio.com. You may also contact Polk Audio Customer Service at 1-800-377-7655 for instructions on where to send the product. You will be required to provide an original receipt or bill of sale, identifying you as the original purchaser and identifying the purchase made through an authorized Polk retailer. You will need to ship the product, prepaid and insured, together with the proof of purchase to Polk Audio, Inc. 1 Viper Way, Vista, CA 92081. Risk of loss or damage in transit shall be borne by the purchaser. Freight collect shipments will be refused.

This warranty is non-transferable and does not apply to any product that has been modified or used in a manner contrary to its intended purpose, and does not cover damage to the product caused by installation or removal of the product. If modification(s) to a mounting surface are made to product(s) that have been substituted under warranty, Polk assumes no responsibility or liability for any modification made to the mounting surface or otherwise. This limited warranty is void if the product has an altered or missing serial number, or if the product was purchased from someone other than an authorized dealer. This limited warranty is void if the product has been damaged by accident or unreasonable use, neglect, improper service or other causes not arising out of defects in material or construction. Product(s) which are found to be damaged by abuse resulting in thermally damaged voice coils are not covered by this warranty but may be replaced at the sole and absolute discretion of Polk. This warranty terminates if you sell or otherwise transfer the product to another party. This limited warranty does not cover cosmetic damage, paint damage, damage to other components, parts or premises, or any consequential damages which may result for any reason. This limited warranty does not cover labor costs for the removal and/or reinstallation of the product.

THIS WARRANTY GIVES YOU SPECIFIC LEGAL RIGHTS AND YOU MAY HAVE OTHER RIGHTS THAT VARY FROM STATE TO STATE. ALL WARRANTIES, INCLUDING BUT NOT LIMITED TO EXPRESS WARRANTY, IMPLIED WARRANTIES OF MERCHANTABILITY AND FITNESS FOR A PARTICULAR PURPOSE ARE EXPRESSLY EXCLUDED AND DISCLAIMED TO THE MAXIMUM EXTENT ALLOWED BY LAW, AND POLK NEITHER ASSUMES NOR AUTHORIZES ANY PERSON TO ASSUME FOR IT ANY LIABILITY IN CONNECTION WITH THE SALE OF THE PRODUCT. POLK HAS ABSOLUTELY NO LIABILITY FOR ANY ACTS OF THIRD PARTIES. SOME STATES DO NOT ALLOW THE EXCLUSION OF CERTAIN IMPLIED WARRANTIES, OR CONDITIONS ON AN IMPLIED WARRANTY, SO THE ABOVE LIMITATION MAY NOT APPLY TO YOU. POLK DOES NOT ACCEPT LIABILITY FOR SPECIAL, INDIRECT, INCIDENTAL, PUNITIVE OR CONSEQUENTIAL DAMAGES, LOST PROFITS, LOST SAVINGS OR DAMAGES RESULTING FROM IMPROPER USE, OR THE INABILITY TO USE THE PRODUCT. THE MAXIMUM LIABILITY FOR WHICH POLK MAY BE RESPONSIBLE SHALL NOT EXCEED THE PURCHASE PRICE OF THE PRODUCT. SOME STATES DO NOT ALLOW THE EXCLUSION OR LIMITATION OF INCIDENTAL OR CONSEQUENTIAL DAMAGES, SO THE ABOVE LIMITATION OR EXCLUSIONS MAY NOT APPLY TO YOU.

Garantie à vie limitée des haut-parleurs «In-Wall» et «In-Ceiling» de marque Polk Audio

Note importante: Cette garantie à vie ne s'applique qu'aux haut-parleurs «In-Wall» et «In-Ceiling» et aux subwoofers CSW vendus après le 9 septembre 2009.

Polk Audio Inc., («Polk»), garantit à l'acheteur au détail original que les haut-parleurs «In-Wall» et «In-Ceiling» de marque Polk Audio, incluant les subwoofers passifs de la série CSW (nommément «le produit»), seront exempts de défauts imputables aux pièces d'origine et à la fabrication pour la vie du produit dans des conditions normales d'usage. En cas de défauts imputables aux pièces d'origine et à la fabrication, Polk, à sa discrétion, (a) réparera le produit ou (b) remplacera le produit. Si le modèle du produit n'est plus disponible et ne peut être réparé efficacement, ou remplacé par un modèle identique, Polk pourra, à sa seule et entière discrétion, remplacer le produit avec un modèle de valeur égale ou supérieure.

Pour obtenir du service sous garantie, consultez les instructions contenues dans votre manuel d'utilisation ou visitez le site web de Polk Audio: www.polkaudio.com. Vous pouvez aussi communiquer avec le Service à la Clientèle de Polk Audio au 1-800-377-7655 pour savoir où expédier le produit. Vous devrez fournir le reçu original de la vente, vous identifiant comme l'acheteur original du produit et attestant que vous avez acheté le produit d'un revendeur autorisé Polk Audio. Vous devrez expédier le produit, franc de port et dûment assuré, avec la preuve d'achat, à Polk Audio, 1 Viper Way, Vista, California 92081. Le propriétaire du produit doit assumer tout risque de perte ou de dommage en transit. Tout fret payable à destination sera refusé.

Cette garantie n'est pas transférable et ne s'applique pas à un produit qui a été modifié ou utilisé de façon non conforme, et ne couvre pas les dommages causés par l'installation ou le démontage du produit. Si des modifications ont été apportées à la surface de montage pour accepter un produit substitué sous garantie, Polk n'assume aucune responsabilité pour toute modification qui aura été apportée à la surface. Cette garantie est annulée si le numéro de série sur le produit a été retiré, altéré ou falsifié ou si le produit a été acheté d'un revendeur non autorisé. Cette garantie est annulée si le produit a été endommagé par accident ou par usage abusif, négligence, service inapproprié ou toute autre cause non imputable aux pièces d'origine et à la fabrication. Les produits dont la bobine mobile a subi des dommages thermiques causés par un usage abusif ne sont pas couverts par cette garantie mais pourraient être remplacés à la seule et entière discrétion de Polk. La garantie sera automatiquement annulée si l'acheteur original vend ou transfère le produit à tout autre parti. Cette garantie ne couvre pas les dommages à la peinture ou au décor, les dommages d'autres composants, les dommages à la pièce ou aux lieux, ou tout dommage conséquent qui pourrait être causé pour toute autre raison. Cette garantie limitée ne couvre pas la main d'oeuvre pour le démontage et/ou la réinstallation du produit.

CETTE GARANTIE VOUS ACCORDE DES DROITS LÉGAUX SPÉCIFIQUES; VOUS POURRIEZ ÉGALEMENT AVOIR D'AUTRES DROITS QUI POURRAIENT VARIER D'ÉTAT EN ÉTAT. TOUTES GARANTIES, INCLUANT MAIS NON LIMITÉES AUX GARANTIES EXPRESSES ET AUX GARANTIES ÉNONCÉES DE COMMERCIALITÉ ET DE COMPATIBILITÉ POUR UTILISATION PARTICULIÈRE, SONT EXPRESSÉMENT EXCLUES ET DÉCLINÉES CONFORMÉMENT À LA PORTÉE MAXIMALE PRÉVUE PAR LA LOI. POLK N'ACCÈPTE AUCUNE RESPONSABILITÉ RELATIVE À LA VENTE DU PRODUIT ET N'AUTORISE AUCUNE PERSONNE À ACCEPTER CETTE RESPONSABILITÉ EN SON NOM. POLK N'ACCÈPTE ABSOLUMENT AUCUNE RESPONSABILITÉ POUR TOUTE ACTION D'UN TIERS PARTI. CERTAINS ÉTATS NE PERMETTANT PAS L'EXCLUSION OU LA LIMITATION DES DOMMAGES INDIRECTS, LES LIMITATIONS ET EXCLUSIONS EXPRIMÉES CI-DESSUS POURRAIENT NE PAS S'APPLIQUER DANS VOTRE CAS. POLK N'ACCÈPTE AUCUNE RESPONSABILITÉ POUR TOUT DOMMAGE PARTICULIER, INDIRECT, ACCESSOIRE OU PUNITIF, PROFITS PERDUS, ÉPARGNES PERDUES, OU TOUT DOMMAGE CAUSÉ PAR UN USAGE ABUSIF OU PAR L'INCAPACITÉ D'UTILISER LE PRODUIT. LA RESPONSABILITÉ MAXIMALE DE POLK NE DÉPASSERA PAS LE PRIX D'ACHAT DU PRODUIT. CERTAINS ÉTATS NE PERMETTANT PAS L'EXCLUSION OU LA LIMITATION DES DOMMAGES INDIRECTS OU ACCESSOIRES, LES LIMITATIONS ET EXCLUSIONS EXPRIMÉES CI-DESSUS POURRAIENT NE PAS S'APPLIQUER DANS VOTRE CAS.

polkaudio[®]

the speaker
specialists[®]

5601 Metro Drive
Baltimore, Maryland 21215
800-377-7655 (outside usA & CANADA: 410-358-3600)
www.polkaudio.com



HBP2144

polkaudio®

the speaker specialists®

80F/X®-RT & 80F/X®-LS
Mounting Template and Instructions
Gabarit D'Installation et Consignes

9 3/8 in.

Follow these steps while installing the 80F/X®-RT & 80F/X®-LS
Étapes à suivre pour installer le 80F/X®-RT et 80F/X®-LS

- 1) Determine speaker location.
Be sure that it does not interfere with studs/joists.
- 2) Hold or tape the template to the mounting location.
- 3) Trace along the outside of the template.
- 4) Carefully cut a hole ensuring that it is no larger than the shape you traced.
- 5) Attach the speaker wires to the terminals on the back of the speaker Use RED for the positive (+) wire and BLACK for the negative (-) wire.
- 6) Position the speaker and tighten the six screws until snug.
CAUTION: DO NOT OVER-TIGHTEN SCREWS!
- 7) Install grille.

- 1) Déterminez l'emplacement.
Assurez le dégagement adéquat des montants/solives.
- 2) Tenez ou fixez le gabarit sur l'emplacement déterminé.
- 3) Tracez le pourtour du gabarit.
- 4) Taillez l'embrasure. Assurez-vous qu'elle n'est pas plus grande que le tracé.
- 5) Connectez les câbles de h.p. aux bornes situées à l'arrière du haut-parleur. ROUGE = fil positif (+) / NOIR = fil négatif (-).
- 6) Installer le haut-parleur et serrez fermement les six vis.
ATTENTION: NE SERREZ PAS TROP LES VIS!
- 7) Installez la grille.